

JAURE®

General Industry drives

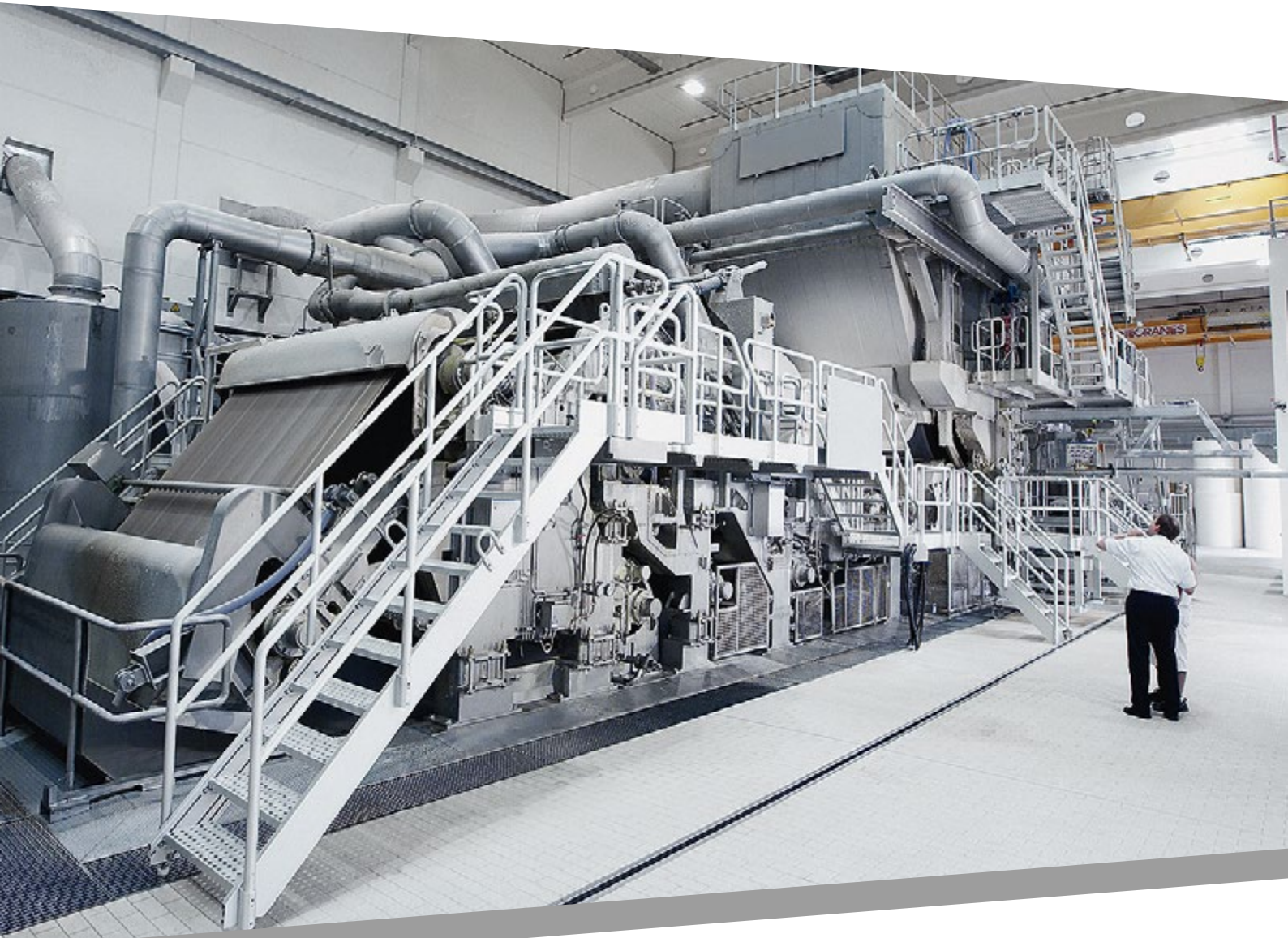

A Regal Brand

REGAL





MOVING YOUR BUSINESS FORWARD

For over 50 years Jaure® has been on the move as a leading supplier of couplings. We provide tailored solutions that bring innovation to your applications. Jaure belongs to the Power Transmission Solutions division of Regal Beloit Corporation. Regal Power Transmission Solutions is comprised of 8 brands: Browning, Jaure, Kop-Flex, McGill, Morse, Rollway, SealMaster and System Plast.

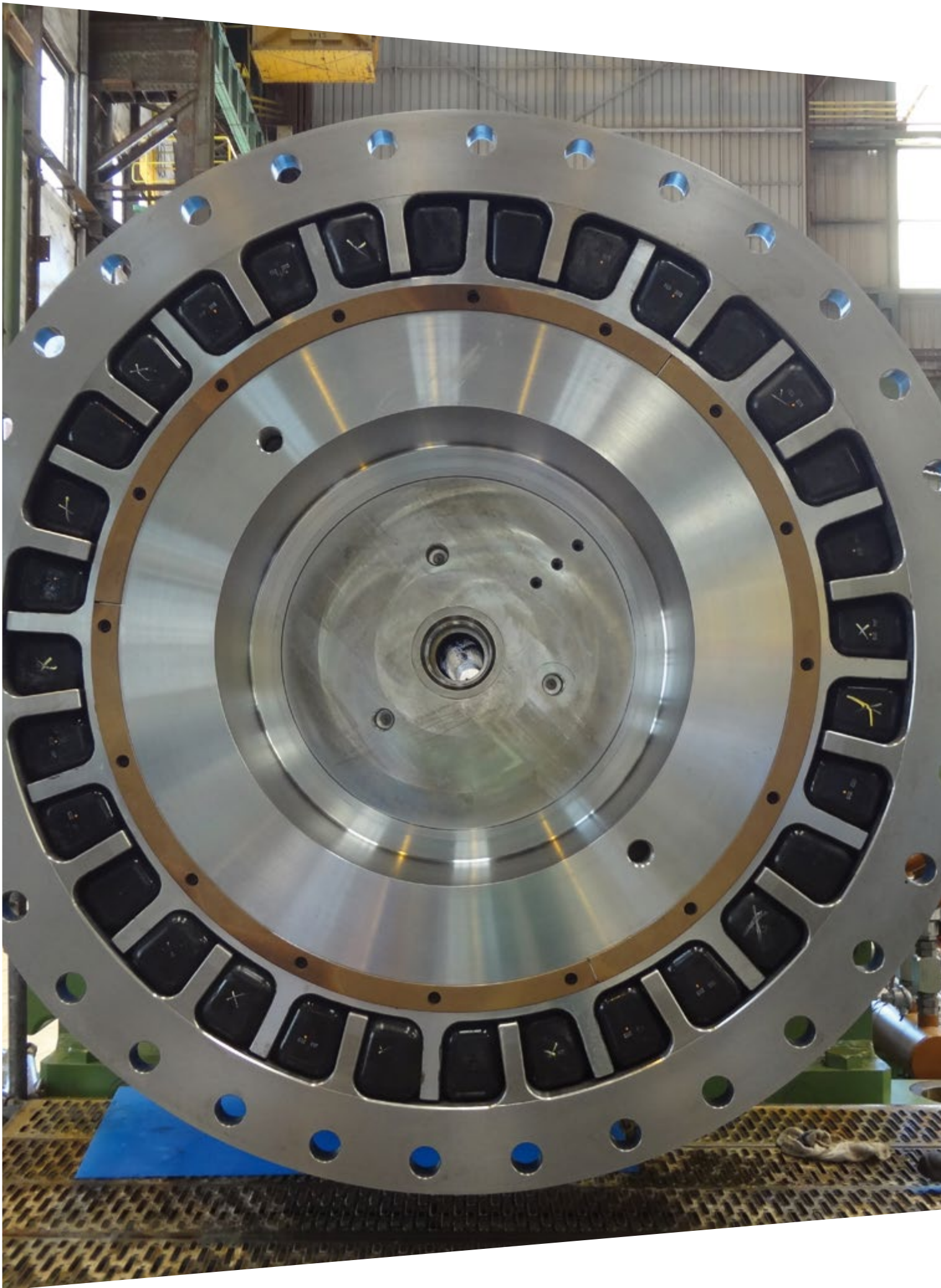



The most suitable Jaure coupling for any application.

Couplings:

MT

Compact gear coupling.

TCB

Barrel coupling for cranes and hoisting applications.

LAMIDISC®

Non lubricated torsionally stiff disc pack coupling.

MAX-C®

Non lubricated high torque capacity resilient coupling.

JAUFLEX®

Non lubricated elastomeric coupling.

RECORD

Lubricated flexible grid coupling.

IXILFLEX®

Bidirectional rubber link coupling for high misalignment.

No matter the application (cranes & hoisting, paper, minerals, etc.) in need of a flexible coupling, Jaure's extensive product portfolio allows us to meet any requirement. Both standard and engineered-to-order coupling solutions are available.

JFTL

Torque limiters to protect the drive train from peak torques.

JCFS & JGFS

Carbon & Glass fiber drive shafts.

JHC

Hydraulic shaft couplings.

Components & Solutions:

JS NUT

Multi-Jack bolt tensioner.

ELECTRONIC WEAR INDICATOR

Remote monitoring of the coupling wear.

GREASE

For high performance, standard and slow speed.

Jaure can provide a turnkey solution for a complete drive, ensuring that all of our solutions are tailored to each application.

Our sales and technical representatives will be glad to assist you.

Cranes & Hoisting

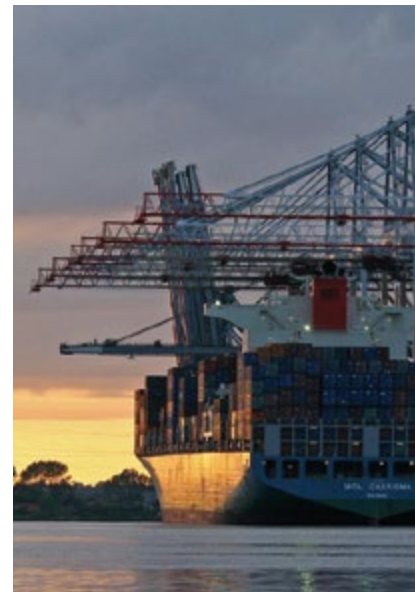

JAURE® BARREL AND GEAR COUPLING

TCB and Heavy duty TCB-HD barrel ranges for hoisting and JAURE® MTF5 gear coupling with brake disc.

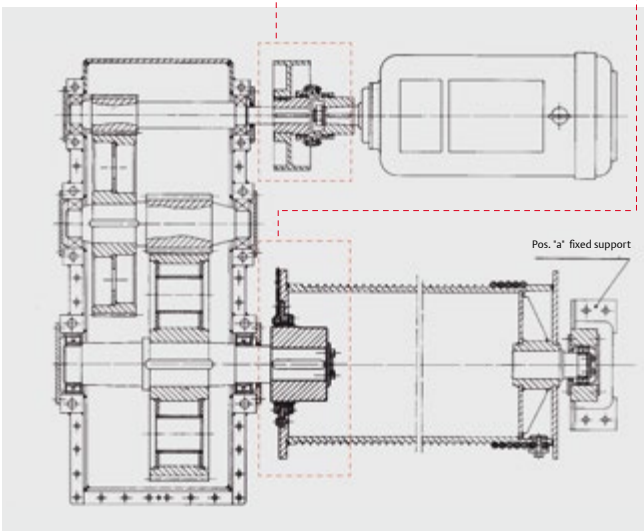
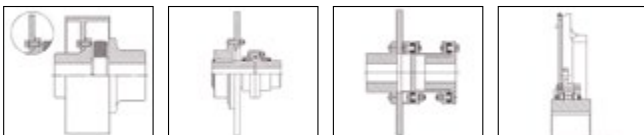

Jaure barrel couplings are recommended for installation in crane lifting mechanisms.

To use a barrel coupling instead of a gear coupling will bring a significant decrease of the space needed for a coupling. Besides, barrel couplings are subjected to much lower bending stress on the root of the teeth and increased safety factor is obtained against peak radial loads.





JAURE® DISC PACK AND ELASTIC COUPLING

Maintenance-free SXFD **Lamidisc®** All-steel disc pack and SDDL **Jauflex®** elastic couplings.

Jaure also provides the coupling between main engine and gear box input shaft. Various types of flexible couplings, MT gear, Lamidisc disc pack and Jauflex elastic with brake disc or drum are delivered according to customer requirement.

An electronic wear indicator feature is also available. This feature allows user to monitor wear remotely. Thousands of Jaure barrel couplings are successfully operating for years in various demanding applications such as container cranes, ladle cranes in steel mills, rubber gantry cranes, travelling cranes for industry applications, etc.

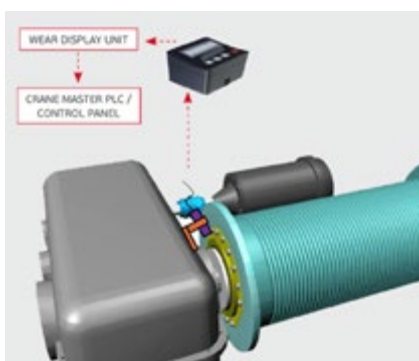

Pulp & Paper

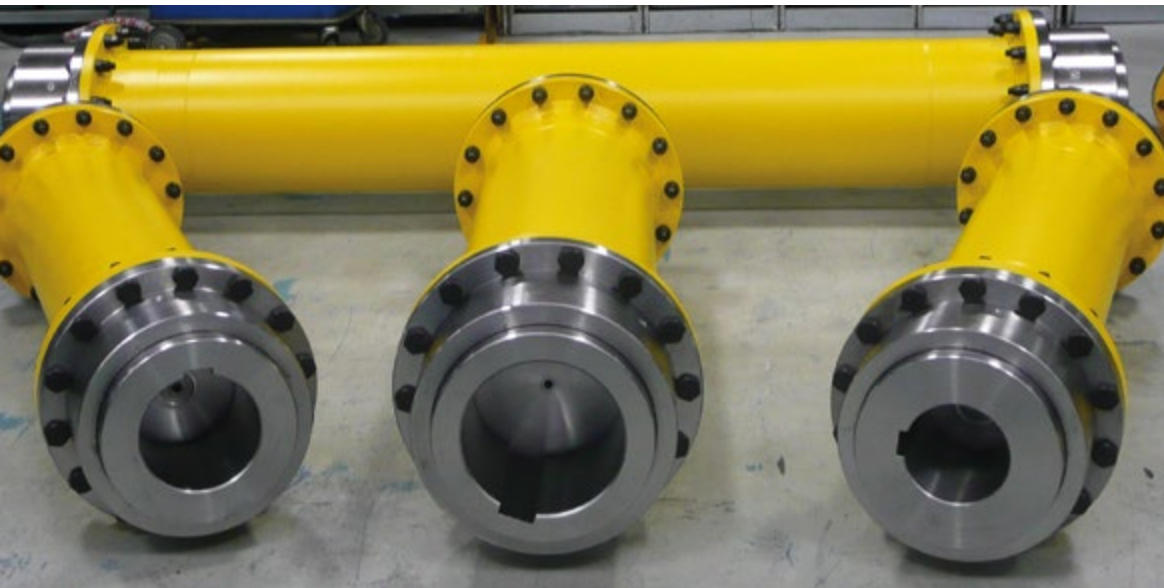

JAURE® GEAR COUPLING

Heavy duty types **MTG-HD-NT**
and **MTGX-HD-NT** with nitrided gears.

Jaure is a global supplier of flexible couplings to customers in the pulp and paper industry. For over 40 years Jaure MT gear couplings have been successfully operating in various lines for the processing of fiber pulps, paper, board and tissue machines.

MT gear couplings are most compact solution for critical applications that demand high torque transmission requirement. As an example engineered-to-order Jaure heavy duty type MT-HD gear couplings are running in some world's biggest refiners.





JAURE® DISC PACK COUPLING

Maintenance-free All-steel **Lamidisc®** disc pack ranges:
DO Drop Out style and **CC-E** with split spacer.

The Jaure Lamidisc disc pack coupling was later introduced to retrofit gear couplings in the production of paper. Lamidisc is designed to operate with no maintenance required. It therefore allows the paper mills to eliminate downtime for maintenance and advances towards a lubrication-free plant environment.

These couplings are used in the two main areas of the paper machine: the wet area and the drying end. Thousands of Lamidisc couplings are running in various processes of the paper production such as presses, dryers, pumps, calenders, reels, roll handling, etc. Our standard program of Lamidisc couplings is adapted to each application need in terms of spam, dynamical balancing, electrical insulating, painting, or any other specific request.

① PRIMARY (HS) COUPLING



② SECONDARY (LS) COUPLING

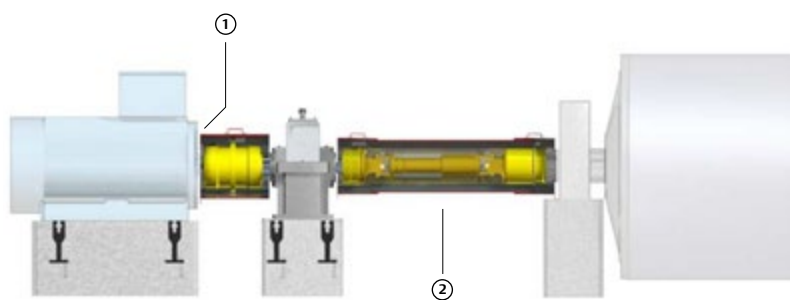

Minerals & Mining

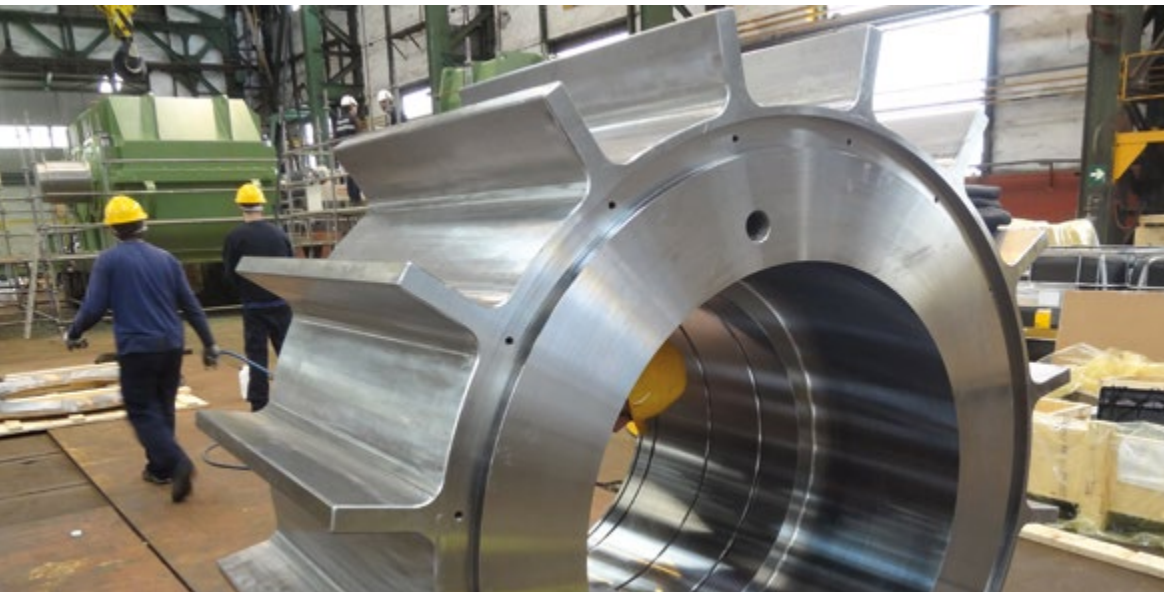

JAURE® GEAR COUPLING AND MULTI-JACK BOLT TENSIONER

Heavy duty type **MTG-HD** gear coupling and **JS nut** multi-jack bolt tensioner.



Backed by extraordinary technological capabilities and resources, Jaure delivers customized heavy duty solutions to the most demanding sectors like minerals and mining processing. Jaure has an extensive product portfolio of flexible couplings, both torsionally rigid and elastic. Jaure heavy duty MT-HD gear and Record grid couplings are made to order to meet the needs of the most demanding mill drives (Ball, SAG, etc).



JAURE® GEAR COUPLING
 MTES disengaging designs
 with lever, screw-jack, etc.



**JAURE® COMBINED DISC
 PACK AND ELASTIC COUPLING**
 Lamidisc® SX with MAX-C®
 rubber in shear.

Auxiliary inching drives are also running with Jaure MTES disengaging couplings.

Manual, pneumatic or hydraulic levers are also delivered on demand. To meet other needs in the mills like torsional damping, dusty atmospheres or reducing downtime for maintenance, Jaure has a product portfolio of non-lubricated couplings such as Lamidisc all steel disc pack or Jaure/Kop-Flex Max-C elastic couplings.



Petrochemical/Oil & Gas



JAURE® DISC PACK AND GEAR COUPLING

DOAE Lamidisc® coupling with electrical insulation and MTNAE gear coupling with electrical insulation.

Jaure has a wide variety of products for use in the oilfield industry. Common solutions include a variety of MT gear couplings and LAMIDISC disc pack couplings which can be customized for vertical installation, electrical insulation, various spans, etc.

Various executions of Jaure couplings meet the requirements of the American Petroleum Institute (API 610 and API 671) and can be also ATEX certified on demand.



Cooling Towers / Machine Tools



JAURE® COMPOLINK® AND COMBINED DISC PACK COUPLING

Composite link coupling and Lamidisc® disc pack coupling in combination with JGFS glass fiber and JCFS carbon fiber spacers.

Jaure composite shaftlines JGFS-glass fiber & JCFS-carbon fiber are combined with Jaure flexible couplings, for installation in high humidity and corrosive atmospheres like cooling towers, for example. These shafts are also used for higher speed applications such as machine tools and test benches.



Service



POWERLIGN® TORQUE MONITORING

To reach desired low operating costs and avoid unscheduled shutdowns, proper drive maintenance is key. Our gear couplings can be repaired for much less than the cost of new ones, and proper maintenance extends the life of the equipment.

Jaure® and Kop-Flex® has an experienced and skilled service team worldwide, which is available to share its expert assistance in designing a predictive and preventive maintenance program.



Torque monitoring

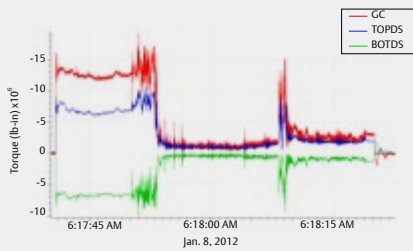
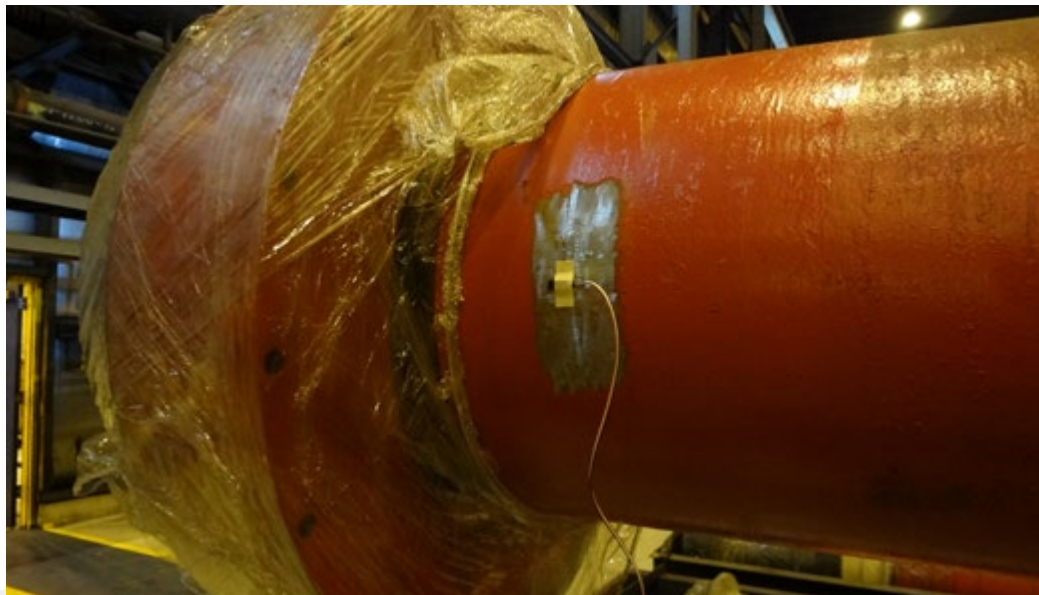

TORQUE MONITORING



KOP-FLEX® COUPLING GREASES

Torque monitoring is a valuable tool for preventative maintenance and problem solving. It provides real-time data to the mill operators.

Main purpose:

- Understanding the real loads under working conditions versus design loads.
- Definition of overload protection devices if needed.
- Definition of the most appropriate coupling solution.
- Effect of transient loads on coupling.



Jaure manufacturing program



Product Brand Name	MT	LAMIDISC®	TCB / TCB-HD	AL-S / AL-SD / ALD	RECORD
Type & Description	Gear	Disc pack	Barrel (drum type)	Gear spindles	Grid / spring type

INDUSTRY APPLICATION					
Metals & Heavy duty	•	•	•	•	•
Minerals & Mills	•	•	•		•
Crane & Hoisting	•	•	•		•
Pulp & Paper	•	•			•
Petrochemical / Oil & Gas	•	•			•
Cooling Towers		•			
Machine Tools		•			
Marine	•	•	•		
Wind Turbines		•			•
Test Benches	•	•			
Railway	•	•			



Special safety heavy duty gas nitrided gears.

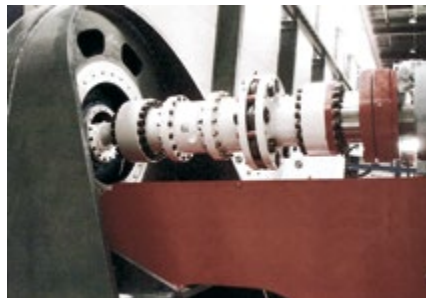

LAMIDISC® Safety coupling on test bench including SAFESET® (SAFESET® from VOITH TURBO).



Type Approvals (Marine & Wind).

COUPLINGS



JAUFLEX®

IXILFLEX®

COMPOLINK®

JFTL TORQUE
LIMITER

JCFS

JHC

Elastic

Elastic Link

Composite Link

Torque Limiter

Composite Shafts

Hydraulic fit
(shaft couplings)

	Elastic	Elastic Link	Composite Link	Torque Limiter	Composite Shafts	Hydraulic fit (shaft couplings)
	•			•		•
	•			•		•
	•			•		
	•	•	•		•	
	•		•		•	
	•		•		•	
	•	•	•	•	•	•
	•	•	•	•	•	•
		•	•		•	•
		•	•	•		



Carbon Fibre Shaft combined with LAMIDISC® coupling.



Torque monitoring on wind turbines.



Double-gear couplings for railway.

Kop-Flex and Jaure manufacturing program

COUPLINGS



Product Brand Name	MAX-C®	HIGH PERFORMANCE PROGRAM			KOP-FLEX GREASE	SERVICE
Type & Description	Heavy duty elastic coupling	GEAR	DISC	DIAPHRAGM	Gear coupling / spindle grease	Repair & maintenance program

INDUSTRY APPLICATION						
Metals & Heavy duty	•				•	•
Minerals & Mills	•				•	•
Crane & Hoisting	•				•	•
Pulp & Paper					•	•
Petrochemical / Oil & Gas	•	•	•	•	•	•
Cooling Towers					•	•
Machine Tools					•	•
Marine	•	•	•	•	•	•
Wind Turbines	•				•	•
Test Benches	•	•	•	•	•	•
Railway	•	•			•	•

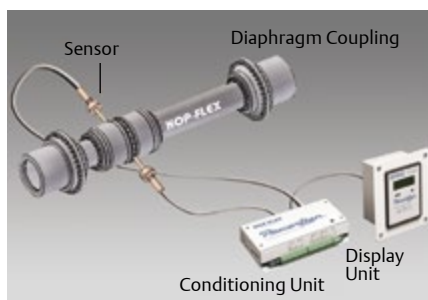

Powerlign® Torque Monitoring.

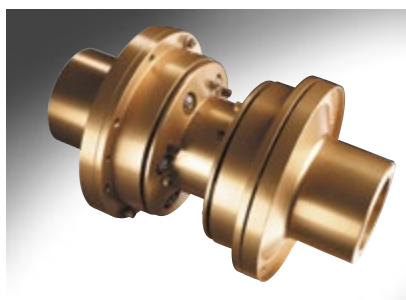

High Performance Solutions.

Global presence

MANUFACTURING FACILITIES & ENGINEERING CENTERS



JAURE® & KOP-FLEX® engineered couplings are designed, manufactured, sold and serviced worldwide, with service provided from specification right through to installation.

All JAURE® & KOP-FLEX® facilities around the globe are state of the art, with access to a large

and experienced engineering staff focused on providing solutions for our customers' requirements.

A dedicated global sales and service team assists you to find the best choice and manage all your coupling needs.



JAURE®. Zizurkil. Spain.



Pune, India.



Nove Mesto, Slovakia.



Zhangzhou, China.



KOP-FLEX®. Baltimore, USA.



Florence, Kentucky, USA.



Rexdale / Toronto, Canada.



Apocadaca, México.

JAURE®

Regal Beloit Spain S.A
Ernio bidea, s/n
20159 ZIZURKIL
(Gipuzkoa) SPAIN

Phone: +34 943 69 00 54
Fax: +34 943 69 02 95

www.RegalPTS.com/Jaure

APPLICATION CONSIDERATIONS

The proper selection and application of power transmission products and components, including the related area of product safety, is the responsibility of the customer. Operating and performance requirements and potential associated issues will vary appreciably depending upon the use and application of such products and components. The scope of the technical and application information included in this publication is necessarily limited. Unusual operating environments and conditions, lubrication requirements, loading supports, and other factors can materially affect the application and operating results of the products and components and the customer should carefully review its requirements. Any technical advice or review furnished by Regal-Beloit America, Inc. and its affiliates with respect to the use of products and components is given in good faith and without charge, and Regal assumes no obligation or liability for the advice given, or results obtained, all such advice and review being given and accepted at customer's risk.

For a copy of our Standard Terms and Conditions of Sale, Disclaimers of Warranty, Limitation of Liability and Remedy, please contact Customer Service at 1-800-626-2120. These terms and conditions of sale, disclaimers and limitations of liability apply to any person who may buy, acquire or use a Regal Beloit America Inc. product referred to herein, including any person who buys from a licensed distributor of these branded products.

Regal, Jaure, and Kop-Flex are trademarks of Regal-Beloit Corporation or one of its affiliated companies.
©2015 Regal-Beloit Corporation, All Rights Reserved. MCB16009E • Form 9874E

A Regal Brand



www.regalbeloit.com